

# *Centor Screening Systems* **CARE & MAINTENANCE GUIDE**



# KEEPING YOUR SCREENS AND SHADES BEAUTIFUL

Thank you for choosing a Centor Screen for your home. The world is beautiful and at Centor we believe in connecting people with the world outside by creating inside-outside living without the compromises. Not only are our products beautiful, they are engineered for all seasons, climates and times of day so you can enjoy the world around you both now and for years to come.

This guide will identify some important operation tips and maintenance requirements to ensure your screens continue to work beautifully and to keep your Centor Warranty valid.



## Operation

Operation of your Centor S2 or S4 screen, or screen and shade could not be simpler.

To draw the screen or shade across the opening use a fingertip to pull on the stile/pull bar and simply pull it across until it clicks onto the opposite side (there is a magnet in the stile/pull bar to firmly “park” the screen or shade and to fully close any small gap). Your screen and/or shade can also be stopped in any position along its route of travel.

If for any reason you feel resistance do not force the screen or shade. Check for any obstruction which may be impeding the smooth operation of the screen/shade. Give your Screens and Shades the care they deserve by operating them gently. If you notice they are not operating satisfactorily, contact your Centor Integrated Dealer immediately. In the meantime, refrain from using them until the issue can be resolved.

The operating mechanism of Centor Screening Systems are not user serviceable. If you have any concerns about the manner of operation, contact Centor on +1 630-957-1000.

Note; the cover on the sill on the bottom of the frame can be simply lifted out to check for any foreign body in the bottom track which may be impeding the movement. Small toys, or parts from assembly sets or beads from necklaces etc. can fall into the bottom guide and should be removed so that they do not block the smooth operation of the screen/shade.

## Be mindful of wind

Shades are not designed to cope with wind. While we have gone to significant lengths to make the shades robust, a large shade is in effect a large sail and may be creased, torn or otherwise damaged by strong wind. Therefore, we recommend that your shades only be used when your doors are closed. If you do have a shade rolled out and wind is creating problems, you should first close the door panels before trying to roll the shades away. This will take the pressure off the fabric, allowing it to roll away easily and prevent potential damage. Screens are designed to be used on an open doorway, but also being a large sail, strong wind gusts may cause problems. If it is windy, roll your screen away. Again, it may be necessary to close the doors first if you’re experiencing very strong wind gusts

## Be mindful of rain and moisture

Centor’s integrated shades and screens are both made from fabrics that are resistant to water damage. However, shade fabrics in particular can be stained by water spreading dust or other contaminants unevenly across the surface of the fabric. Therefore, only use the shades while the doors are closed so that they do not get wet from rain. Localized wetting should be dabbed away immediately to minimize the risk of staining. Be sure your shade or screen is dry before rolling it away. Rolling away a wet fabric slows down the drying process and can lead to mildew or mold growth. If they get wet, remove excess moisture and leave them out to dry. If interior surfaces become wet, dry them as soon as possible using a paper towel or a soft cloth.

# KEEPING YOUR SCREENS AND SHADES BEAUTIFUL



## Cleaning

### Frequency

These cleaning procedures need to be carried out according to the following schedule in order to maintain the validity of your Centor warranty:

- General environments: 6 monthly
- Coastal & industrial environments\*: 3 monthly

\*Coastal environments are defined as any residency within two miles of a body of salt water.

### General

Vacuum floor channels by removing the sill cover regularly to remove debris. A build-up of sand, leaves or animal hair can affect the operation of your door, screen and/or shade.

### Screens

For a fast and easy clean, insect screen mesh can be vacuumed using a soft brush attachment. For a more thorough clean, gently wipe down the insect mesh with a soft cloth dampened in water and a few drops of mild detergent.

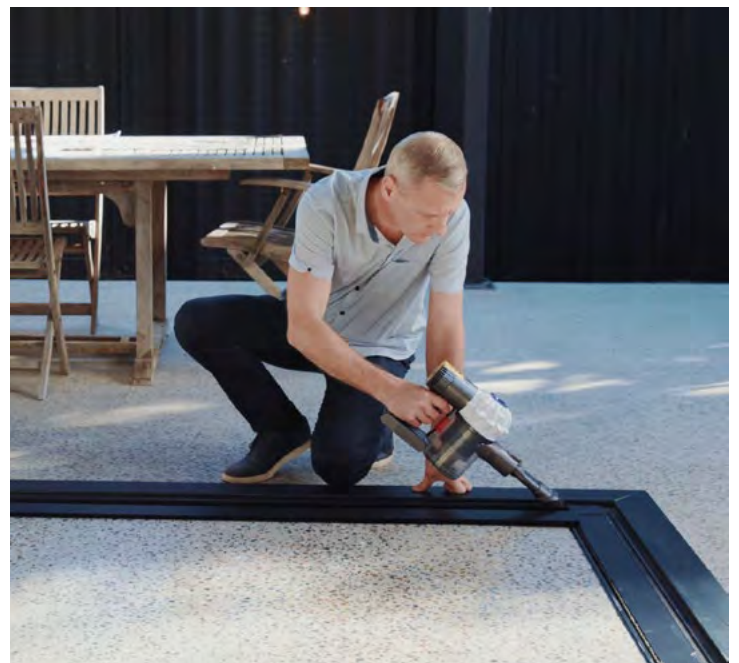

# CLEANING YOUR FLOOR CHANNELS

1. Ensure screens are open

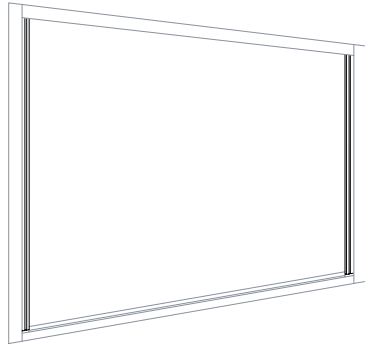

2. Remove sill cover

Carefully lift sill cover up and away from you

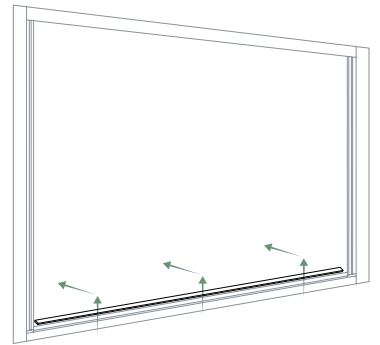

## S2 Screen System:

3. Remove sill-end covers

- a) Locate the pull strap

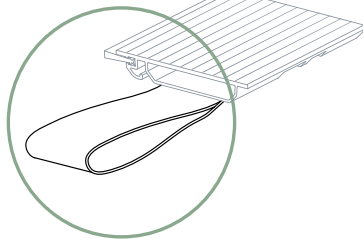

- b) Use the pull strap to pull sill-end cover away from jamb in a perpendicular motion

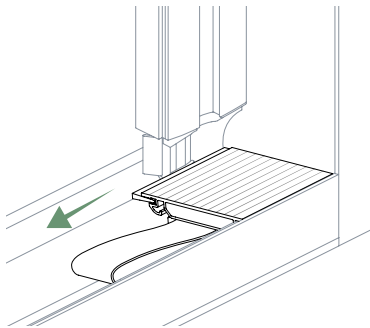

## S4 Screen System:

3. Remove sill-end covers

- a) Gently press the release button located underneath the sill-end cover

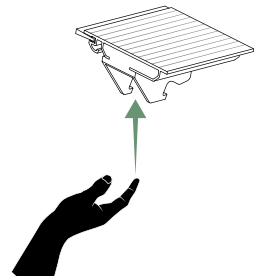

- b) While holding down the button, pull sill-end cover away from jamb in a perpendicular motion

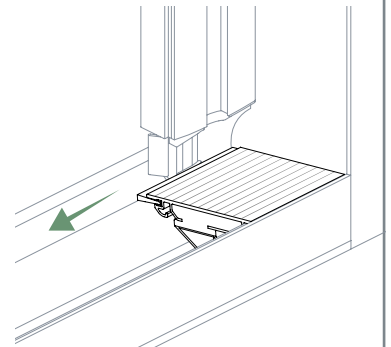

# CLEANING YOUR FLOOR CHANNELS (CONT.)

4. Clean and vacuum any dirt, hair and debris from the sill

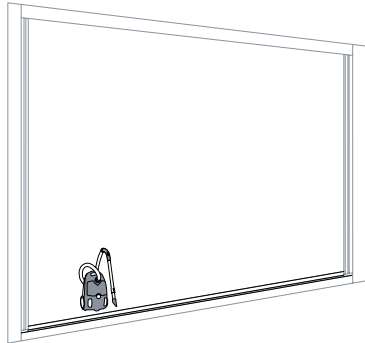

5. Ensure cable and pulley are clear of debris

Located underneath sill-end covers

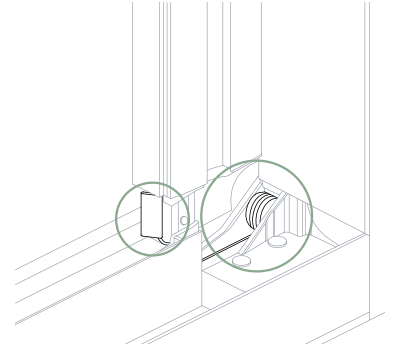

6. Replace sill-end covers

Gently lever the tip of the sill-end cover and push towards jamb to click into place

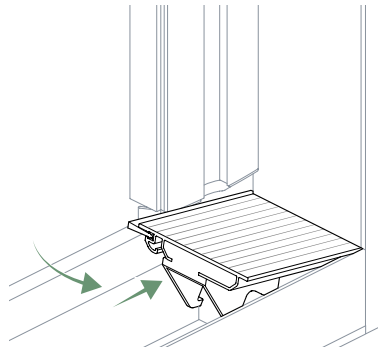

7. Replace sill cover

Place sill cover in a downwards motion

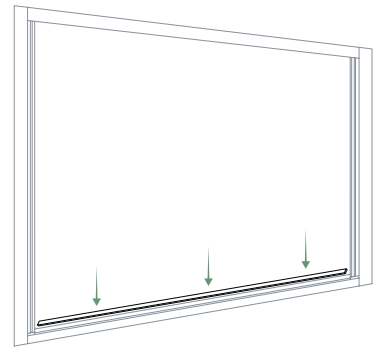

NB Floor channels in high-maintenance situations (eg. within the vicinity of dogs or the beach) need to be cleaned more frequently.

# KEEPING YOUR SHADES BEAUTIFUL



## Protect the fabric

Give your fabric the best chance to stay clean and beautiful for years to come.

- Roll it away when not serving a useful purpose.
- Clean contaminants and marks from the fabric as soon as possible.
- When cleaning the fabric, use the least invasive, simple procedures first, before progressing to a more aggressive approach.

In high-use or dirty environments consider the application of a high quality fabric protection treatment (eg. Scotchguard Fabric Protector).

These coatings will tend to eliminate static charge build-up, making dust and dirt less likely to adhere to the surface.

Make sure that the treatment is applied in accordance with the manufacturer's instructions or by a professional.

## Before treating marks:

1. Assess the nature of the contaminant material before trying to remove it. Some contaminants will only be made worse by trying to remove them. For example, a dry mark is best removed without water as wetting can spread the mark further into the material.
2. Always work in the least visible area first, and if applying any liquids, test first in an inconspicuous area of the fabric. Water marks can be left after cleaning with liquids if the fabric is not dried properly.
3. When cleaning marks, always work from the outside-in to avoid spreading the contaminated area.

# KEEPING YOUR SHADES BEAUTIFUL



## Identify the source of the mark

1. Inspect the soiled area closely.
2. If you are sure you know what the contaminant is, then proceed to relevant treatment steps.
3. If unsure of what the contaminant is, trial cleaning steps very carefully, working through processes in this order:
  - Dry particulate matter (dust, dirt).
  - Grease and fingermarks.
  - Wine and plant juices.

## Important notes for all cleaning processes

In all of the following processes, be sure to:

- Avoid working the contaminant into the fabric. Do not rub the mark.
- Work on a localized, inconspicuous area first.
- Avoid applying wetting agents to the fabric if possible – especially to the backing on blackout fabrics.
- Use cotton cloths for cleaning rather than synthetic materials (such as microfiber). Synthetic cloths tend to generate static charge in the fabric, which can make the contaminants adhere more aggressively.

- Avoid spreading the contaminant:
  - Always work from outside in.
  - When using a vacuum head, brush or cloth that will make contact with the fabric surface, ensure it's clean first.
- If any liquids are present, either as the contaminant or cleaning fluids, ensure that any dampness is sponged out as well as possible using a clean, dry cotton cloth.
  - If practical, after sponging, force dry gently with a hair dryer (cool or warm air only) or similar, working from the center of the damp area outwards to minimize possible water marks upon drying. Do not use hot air to dry.
  - Leave the fabric to fully air dry before rolling the shade away.
- Centor recommends using deionized water wherever water is required for the cleaning process. Tap water carries salts and other contaminants that can leave stains. In addition, deionized water will tend to dissolve minerals and salts from contaminated sites on the fabric better than tap water.

Deionized water from a new container is always more active than that from an old, part-used container.

# KEEPING YOUR SHADES BEAUTIFUL

## Dry particulate matter (dust,dirt)

Dust and dirt can usually be successfully removed from the fabric and also from the backing of blackout fabric. The fabric is factory treated so that dust and dirt will not readily adhere to the fabric.

1. Vacuum the area without making direct contact with the fabric by the vacuum nozzle. This will require using a vacuum rod with a brush head attachment.
2. Use a clean brush to help dislodge adhered particles, working in one direction only and using the tip only of the brush to try to flick the particles off. Use in conjunction with a vacuum as in step 1.
3. Using a piece of clean cotton cloth, wipe in one direction only (do not scrub) from outside the mark towards the center. Use a clean area of the cloth with each wipe. Apply the vacuum again as per step 1.
4. With a piece of adhesive tape, touch the adhesive surface lightly onto dirt marks and lift particles away from the surface. Repeat several times using a clean piece of tape, then try gently rubbing the back of the tape while the adhesive side is in contact with the marked surface.
5. Use a very lightly dampened cotton cloth, wipe in one direction only (do not scrub) working from outside the mark towards the center. Use a clean area of the cloth with each wipe. If doing a large area, change or clean the cloth regularly.

## Grease and fingermarks

Grease is a difficult contaminant to remove from the fabric as it gets locked between the fibers from where it is difficult to dislodge.

1. Prepare a 1:1 solution of white vinegar and warm (not cold), clean deionized water.
2. Spray the solution from an atomizing bottle or dab on the mark with a clean cotton cloth soaked in some of the vinegar solution. Do not apply so much solution that runs occur; if they do, then sponge them up immediately with a dry cotton cloth. Do not rub the soiled area with the cloth as this may work the grease further into the fibers.
3. Immediately dampen another clean cloth in the solvent solution and gently sponge the soiled area to lift the dissolved grease away from the fabric. Note: solvents will dry fast, so ensure you have this mixture ready to go while the solvent is still wet.
4. Using a clean part of the dampened cloth, repeat the sponging process.
5. Repeat steps 1–4 above.
6. If repeated dabbing with the cloth dampened in the solvent solution does not work, then move to light wiping in one direction at a time, always working from outside to the center of the mark.

Do not rub the backing on blackout fabric when using solvents of any kind.

If the vinegar solution fails to lift the stain, undiluted rubbing alcohol (e.g. denatured alcohol, methylated spirits) or similar solvents can be trialled in place of the vinegar following steps 1–6 above.

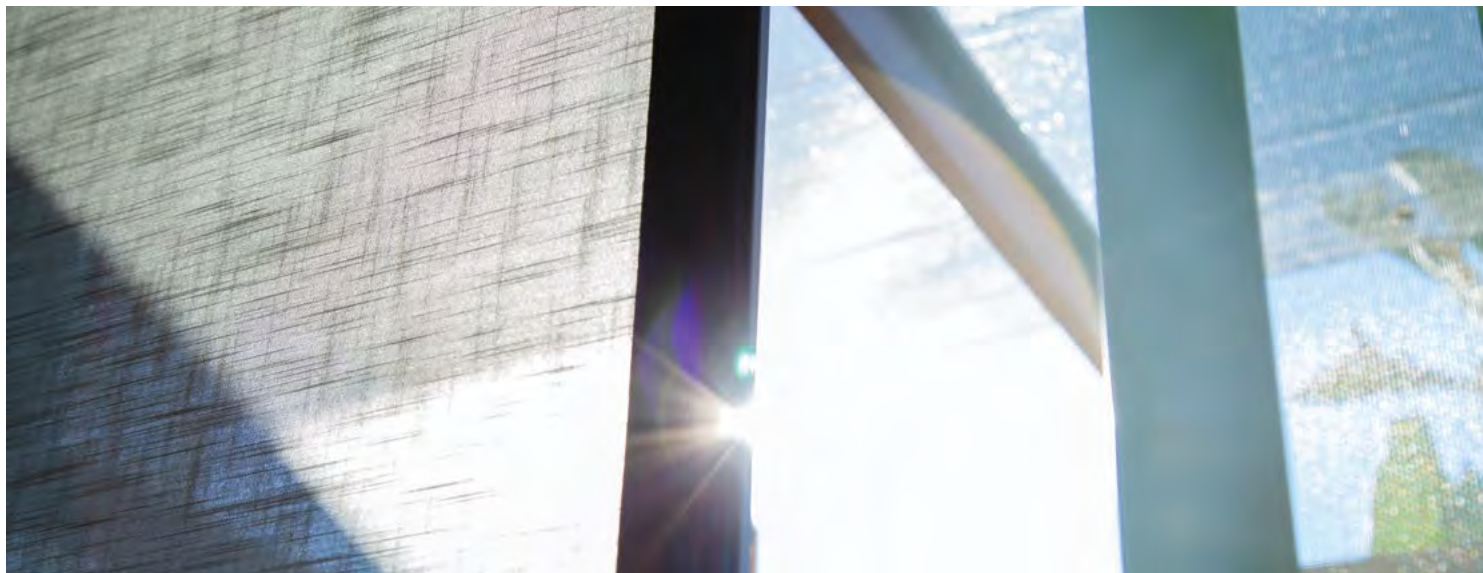



# KEEPING YOUR SHADES BEAUTIFUL

## Wine and plant juices

Remove as much of the liquid as soon as possible with a dry cloth, avoiding spreading the stain further.

1. Dab lightly at the wet mark with a dry, clean cotton cloth, working from the outside-in.
2. Put a few drops of dish-washing liquid in a bowl of warm deionized water.
3. Lightly dampen a clean cotton cloth in the deionized water and detergent, then dab gently at the mark. Do not rub.
4. Repeat step 3. Be sure to use a clean area of the cloth each time to avoid re-contaminating the fabric.
5. Ensure that any dampness in the fabric is sponged out as well as possible using a clean, dry cotton cloth.
6. If practical, after sponging, force dry gently with a hair dryer or similar, working from the center of the damp area outwards to minimize possible water marks. Do not use hot air to dry.
7. Leave the fabric to fully air dry before rolling the shade away.

If staining has occurred, it may be possible to remove or reduce the visibility of the stain by oxidizing it with hydrogen peroxide.

1. Prepare a diluted water/peroxide mix (maximum 3:2 of deionized water/peroxide). Be sure to add the peroxide to the water as per the directions on the peroxide bottle.
2. Using an atomizing spray bottle or a clean cotton cloth, carefully apply a small amount of the mixture to the stain.
3. After approximately 60 seconds, dab the liquid away with a paper towel or clean cotton cloth lightly dampened with deionized water and a few drops of dish-washing liquid.
4. Repeat application and dabbing process, increasing delay time progressively.
5. Do not allow the mixture to dry on the surface. Sponge dampness away with a dry, clean cotton cloth.
6. Leave the fabric to fully air dry before rolling the shade away.

## Insects and blood

Trapped insects can imprint on both sides of the fabric and effective removal will depend on the type of insect and the duration it has been left on the fabric.

1. Treat a dead insect or lizard as dry particulate matter, removing as much matter as possible without using liquid cleaners of any sort.
2. Wet blood stains should be dabbed away as soon as possible using a paper towel.
3. Treat any remaining contaminant as for wine and plant juices

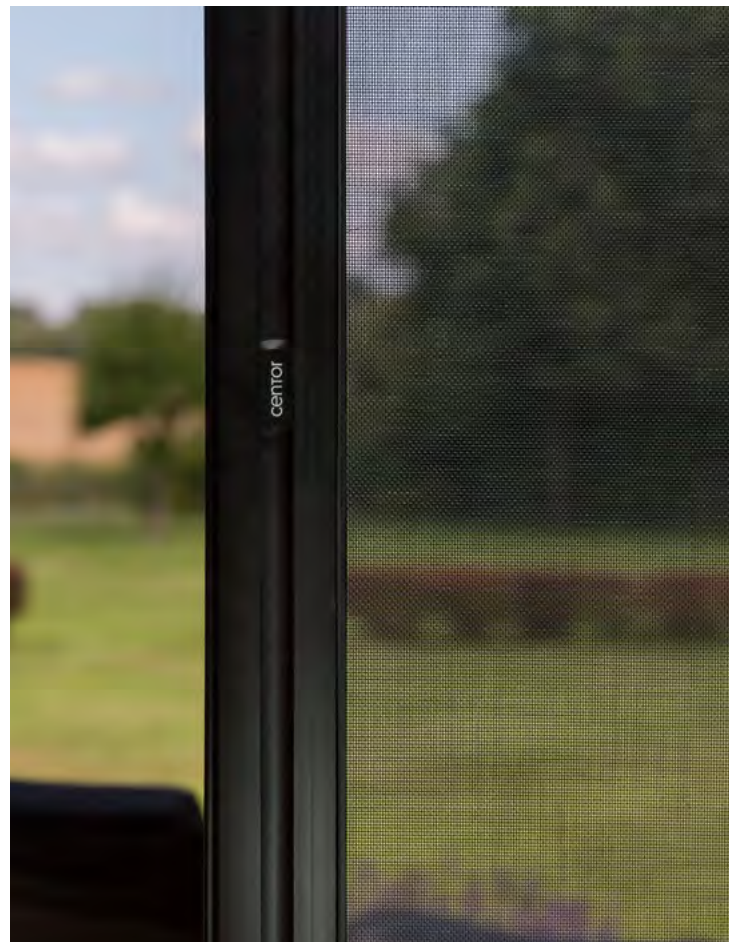

## QUESTIONS? WE CAN HELP

Please do not hesitate to contact us should you need assistance.

### **Centor North America Inc**

+1 630-957-1000

mail.us@centor.com

For optimized service, please let us know your product's serial number.  
This can be found on the underside of the sill cover.

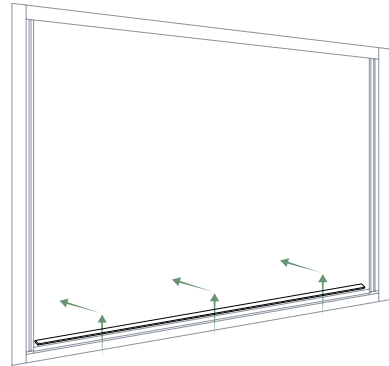

NB Photograph is demonstrative only.  
Every Centor product has a unique  
serial number.

